

# Model No.UE001G CORDLESS EDGER

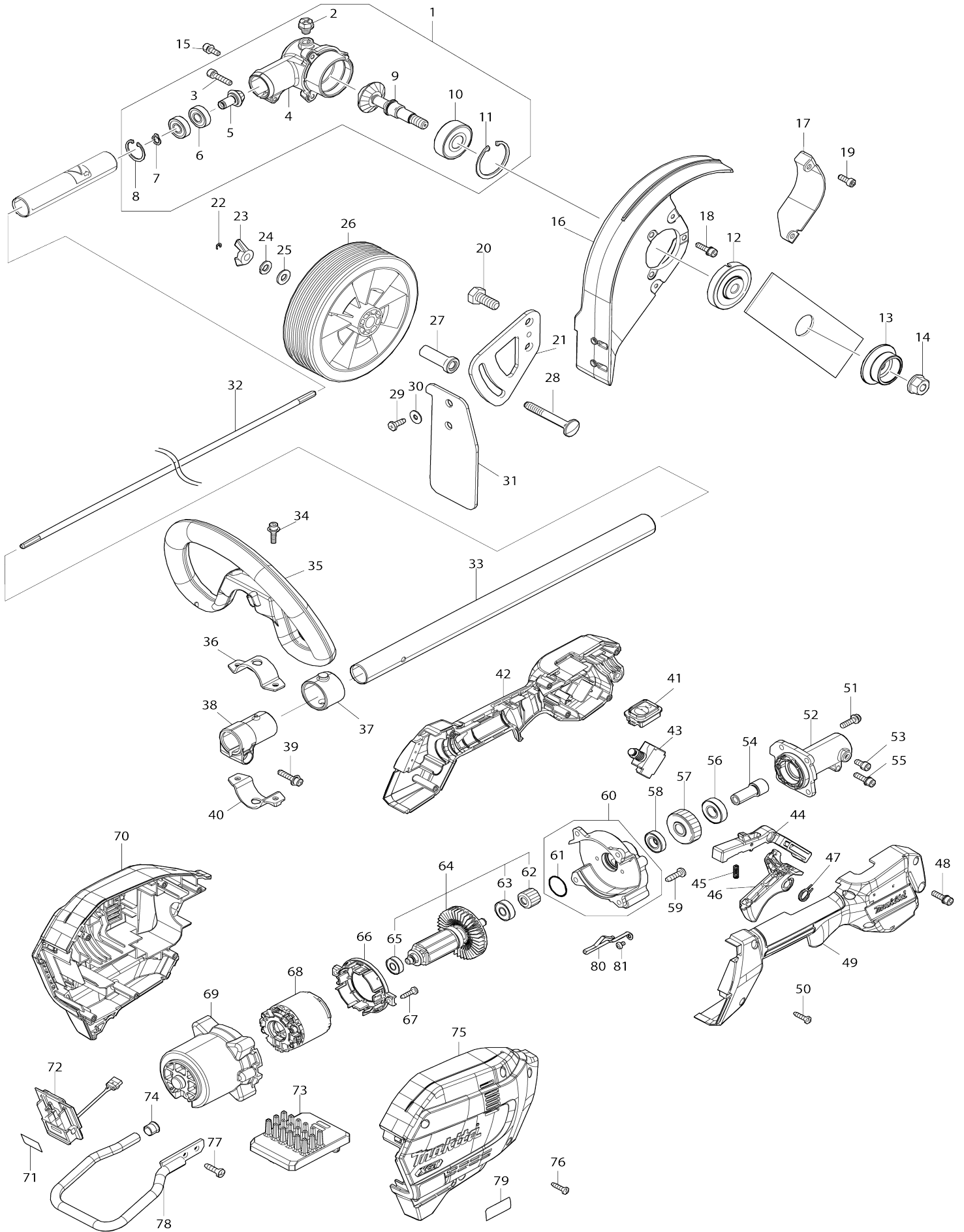

Model No.UE001G CORDLESS EDGER

Item No.	Parts No.	Description	Interchangability	Q'ty	New/Old	Note1	Note2
001	126414-6	GEAR CASE ASS'Y		1			
001		INC. 2-11					
002	265590-2	+HEX.BOLT M8X10 WITH R		1			
003	922241-7	HEX. SOCKET HEAD BOLT M5X25		1			
004	319102-4	GEAR CASE		1			
005	227629-9	SPIRAL BEVEL GEAR 14		1			
006	210049-4	BALL BEARING 609ZZ		2			
007	961005-4	RETAINING RING S-9		1			
008	962103-7	RETAINING RING R-24		1			
009	126415-4	CUTTER SHAFT ASS'Y		1			
010	211231-8	BALL BEARING 6302DDW		1			
011	962201-7	RETAINING RING (INT) R-42		1			
012	326734-0	RECEIVE WASHER		1			
013	326381-7	CLAMP		1			
014	264025-0	HEX. NUT M10-17		1			
015	922218-2	H.S.H.BOLT M5X14 WITH WR		1			
016	319103-2	BLADE CASE		1			
017	346759-8	GUARD PLATE		1			
018	922233-6	H.S.H.BOLT M5X20 WITH WR		3			
019	266874-1	H.S.H.BOLT M5X14		2			
020	921542-0	HEX. BOLT M10X25		2			
021	346758-0	PLATE		1			
022	234355-3	RING SPRING 5		1			
023	934401-9	WING NUT M8		1			
024	942201-3	SPRING WASHER 8		1			
025	941201-0	FLAT WASHER 8		1			
026	454843-6	WHEEL		1			
027	257821-3	SLEEVE 8		1			
028	266937-3	C.HEAD SQUARE NECK BOLT M8 X64		1			
029	266027-2	TAPPING SCREW CT5X16		2			
030	253804-1	FLAT WASHER 6		2			
031	424615-3	DEFLECTOR		1			
032	327056-1	SHAFT		1			
033	1410L1-4	SHAFT PIPE COMPLETE		1			
C10	819312-8	MAKITA LOGO LABEL		1			
C20	8079M1-2	CAUTION LABEL		1			
034	922234-4	H.S.H.BOLT M5X20 WITH WG		2			
035	457267-5	LOOP HANDLE		1			
C10	263005-3	RUBBER PIN 6		1			
036	347113-9	UPPER CLAMP 35		1			
037	424942-8	DAMPER		1			
038	457269-1	PIPE HOLDER 24		1			
039	922244-1	H.S.H.BOLT M5X25 WITH WG		1			
040	347114-7	LOWER CLAMP 35		1			
041	140X08-7	SWITCH CIRCUIT COMPLETE		1			
C10	810D46-0	SWITCH LABEL		1			
042	1830W8-1	GRIP SET		1			

042		INC. 49				
043	651492-2	SWITCH C3JR-1A-PAXD3		1		
044	141X89-4	LOCK OFF LEVER COMPLETE		1		
045	233101-1	COMPRESSION SPRING 4		1		
046	459758-2	SWITCH LEVER		1		
047	233622-3	TORSION SPRING 12		1		
048	922233-6	H.S.H.BOLT M5X20 WITH WR		1		
049	1830W8-1	GRIP SET		1		
049		INC. 42				
050	266326-2	TAPPING SCREW 4X18		6		
051	911233-1	PAN HEAD SCREW M5X20		4		
052	140Y38-4	PIPE BRACKET COMPLETE		1		
C10	263002-9	RUBBER PIN 4		1		
053	922211-6	H.S.H.BOLT M5X12 WITH W		1		
054	325811-5	SPINDLE HUB		1		
055	922233-6	H.S.H.BOLT M5X20 WITH WR		1		
056	211131-2	BALL BEARING 6001DDW		1		
057	227848-7	HELICAL GEAR 33		1		
058	211150-8	BALL BEARING 6901ZZ		1		
059	266420-0	TAPPING SCREW 5X20		4		
060	136368-9	GEAR BOX ASSY		1		
060		INC. 61				
061	213961-7	O RING 22		1		
062	227834-8	HELICAL GEAR 16		1		
063	210005-4	BALL BEARING 608DDW		1		
064	519647-4	ROTOR ASSY		1		
064		INC. 62,63,65				
065	210062-2	BALL BEARING 607ZZ		1		
066	459764-7	BAFFLE PLATE		1		
067	266326-2	TAPPING SCREW 4X18		2		
068	629A25-7	STATOR		1		
069	412961-6	MOTOR HOUSING		1		
070	183S87-2	HOUSING SET		1		
C10	263005-3	RUBBER PIN 6		2		
070		INC. 75				
071	8147E0-9	UE001G SERIAL NO. LABEL		1		
072	632P49-4	TERMINAL UNIT		1		
073	620P54-3	CONTROLLER		1		
074	422230-7	CAP		1		
075	183S87-2	HOUSING SET		1		
C10	263005-3	RUBBER PIN 6		2		
075		INC. 70				
076	266326-2	TAPPING SCREW 4X18		6		
077	266420-0	TAPPING SCREW 5X20		2		
078	347752-5	BATTERY GUARD		1		
079	8145Y3-1	UE001G NAME PLATE		1		
080	654886-0	EARTH PLATE		1		
081	911102-6	PAN HEAD SCREW M4X6		1		
A01	422A15-7	CAP 24		1		
A02	424434-7	CAP 24		1		
A03	196745-7	BLADE SET		1		

A04	782238-6	BOX WRENCH 17		1		
A05	783202-0	HEX. WRENCH 4		1		
A06	831304-7	ACCESSORY BAG		1		
F01	196745-7	BLADE SET		1		

Please state Parts No. when your order.

Print Date 07. 10. 2024